

MLT 845

AGRICULTURAL HANDLING solutions

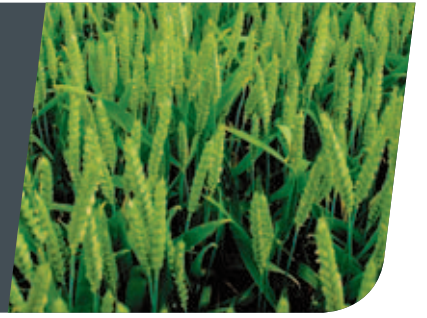

A PASSION FOR FARMING



As partners to the farming industry for more than 20 years, we know your business is **demanding**, and on today's modern farm the materials handling plays an important part in the daily farm handling jobs, so you can be sure you'll be able to find within our farming range **THE** Manitou you need.

The MLT 845 rough terrain telehandler is the ideal choice for **performance**. Its impressive capabilities enable you to carry out all of your **farm handling**

tasks: animal feed, bulk loading and unloading, hay and straw handling, etc. Grain/feed merchants, agricultural contractors or cooperatives will appreciate the qualities of this machine. More than just a handling solution, Manitou offers you a product which both looks good and is comfortable to use. The MLT 845 benefits from innovations such as: JSM*, new cooling system, ECS** ... In short, you gain both in **comfort** and **productivity**.

When you choose Manitou, you can count on a fork lift truck for long term durability. You also benefit from the package of services provided by your dealer: after-sales service, servicing and maintenance contracts, on-site repairs and financing solutions, etc.

Why all this? Because, like you, we take pleasure in a **job well done!**



* Joystick Switch and Move: patent applied for by Manitou BF
** Easy Connect System: hydraulic decompression of the accessory line

“A real agricultural handling **solution**”



PERFORMANCE ON YOUR FARM

4500 kg:

The MLT 845's maximum capacity allows you to move up to 4.5 tonnes.

7.55 m:

The boom of the MLT 845 lets you carry loads up to 7.55 m in height.

2.42 m:

The narrower width at 2.50 m allows your machine to be transported by lorry.



Really rugged!

The MLT 845-120 or 845-120 H has been designed for intensive usage cycles with a heavy duty boom to meet all your requirements in terms of strength. The cooling system has been designed so you can work for extended periods without worry.



Exceptional capacities...

With dimensions much more compact than a traditional wheel loader, the MLT 845 is an example of versatility (width 2.42 m, height 2.58 m). Its maximum capacity of 4.5 tonnes and a lifting height of 7.5 m facilitate both handling and loading.

Goes anywhere

Agricultural profile tyres, high ground clearance (45 cm) and impressive tractive effort will get you out of any situation. The MLT 845 can be used on a variety of applications.



YOU FEEL GOOD...



The interior of the MLT leaves nothing to be desired with its superb bodywork. The driving position has been **ergonomically designed** for maximum comfort. It is fitted with a cloth seat and the fully adjustable steering column can be adapted to suit. Ventilation outlets, sun visor, roof screen, etc. all help to provide you with a comfortable working environment..

Exclusive to Manitou, **JSM** lets you control all movements with one hand safely and effortlessly: raising and lowering the boom, extending and retracting the telescopic boom, crowding and tilting, auxiliary service for operating attachments and also forward/reverse direction of travel. You always keep one hand on the steering wheel to maintain full control of your MLT.

Low noise levels are achieved through the full **soundproofing** of the cab (only 80 dB) and the insulation of the engine compartment.

The dashboard has an analogue display which gives all the information you need during your working day: hour meter, speed, oil temperature, fuel level, etc.





“...but you have
to go home
in the end!”



**“Adapting
to your requirements”**

EACH TO THEIR OWN **STYLE**

Reacting to customer choice is a Manitou principle. That's the reason you **can choose between** 3 levels of finish: **Classic**, **Premium** and **Elite**.

Because all your requirements are important, Manitou provides you with complete peace of mind in all versions of the MLT.



CLASSIC

In the **Classic** version, your comfort is increased by:

- Mechanical cloth seat
- Rear-view mirror
- Radio player
- Radiator auto cleaning system

PREMIUM

You are not just opting for a Manitou, but for **your** Manitou...

The **Premium** finish is differentiated by a number of practical and innovative items:

- Pneumatic cloth seat
- Rear-view mirror
- CD/MP3 car radio
- Air conditioning
- Attachment line decompression system: Easy Connect System
- Radiator auto cleaning system

ELITE

The **Elite** version offers a top specification model:

- Low-frequency pneumatic cloth seat
- Rear-view mirror
- Bluetooth car radio
- Air conditioning
- Boom suspension
- Attachment line decompression system: Easy Connect System
- Self-cleaning pre-filter
- Radiator auto cleaning system

“**Optimising**
the power of
your **engine**”



DESIGNED TO OPTIMISE POWER AND FUEL EFFICIENCY

Each telehandler must have a **suitable power unit** to give you the best engine/machine torque: too little power and you lose efficiency, too much power could increase consumption to no effect.

The MLT 845 is powered by a **MERCEDES 4.2 I, 121 HP**, four-cylinder engine. Providing you with the capacities required and an ideal power/weight ratio, this engine will support you in everything you do.



The **hydrostatic** transmission (MLT 845-120 H) is fitted with a **2-speed mechanical gearbox**. The MLT 845-120 uses a **torque converter** transmission fitted with a **4-speed mechanical gearbox**.

The **LSU system** (Load Sensing Ultra) lets you **build up movements** to work faster. The **150 l/270 bar** hydraulic pump, provides speed and intelligent flow rate management.

121 HP:

This Mercedes engine offers an ideal power/weight ratio. The 121 HP available provide you with efficient daily fuel consumption.

150 l/min:

The hydraulic pump of your MLT 845, combined with the JSM, delivers a maximum flow rate of 150 l/min for quick and accurate movements.

**“Work quickly
and effectively”**



YOU WILL HAVE TIME TO SPARE

Save yourself time to concentrate on what matters - that's Manitou's philosophy when it comes to handling: fast working cycles and driver comfort are good examples.

For maximum efficiency, Manitou offers you a machine which is simple to use. **Quick and easy to learn** (JSM, controls perfectly placed), your machine is the solution to all your farm handling duties.

Performance is essential! With your MLT 845, you will be able to do even more work: the more time you spend at the wheel the more your efficiency will be increased.

You have a maximum capacity of **4.5 tonnes**, combined with a **2-stage boom**, providing quicker movements.

A wide range of **attachments** are available, ideally suited to your Manitou to increase **utilisation and versatility**. Whatever the job, Manitou can provide a solution to maximise your farm handling requirements with complete safety. Collector brush, bale clamp, multifunction grab bucket, boom, silo unloader bucket, etc. Manitou supports you in all your applications.



Handling cycle time unladen

Movement	MLT 845-120 / 120 H
LIFTING	8.40 sec
LOWERING	6.00 sec
EXTENSION	9.70 sec
RETRACTION	8.30 sec
CROWD	3.70 sec
DUMP	3.30 sec

4 x 4 x 4:

4 wheel drive and 4 wheel steer = manoeuvrability for getting out of all situations.

2 stages:

A 2-stage boom providing a faster cycle and a robust build for intensive applications.

YOU ARE SAFE

SORRY, WE DON'T DESIGN TOYS

Our **design department**, employing more than 200 engineers and technicians, have specialised in the design of agricultural telehandlers **for more than 20 years**. With more than 50 registered patents, our knowledge and expertise with regard to the structure of the machine offers you reliability and durability. A fully comprehensive testing procedure and "best practice" methods are applied to ensure quality manufacturing at all levels, utilising all the latest modern technology.

Specialists in agriculture, Manitou develop their product range with the customer in mind, selecting components to suit the most arduous farm handling needs, **your machine like the Manitou company is 100% dedicated to agriculture**: the tyres, transmission and even the cooling system have been logically chosen and assembled.



**“The assurance of working
in total safety”**

“A machine **100%** dedicated to **agricultural use**”

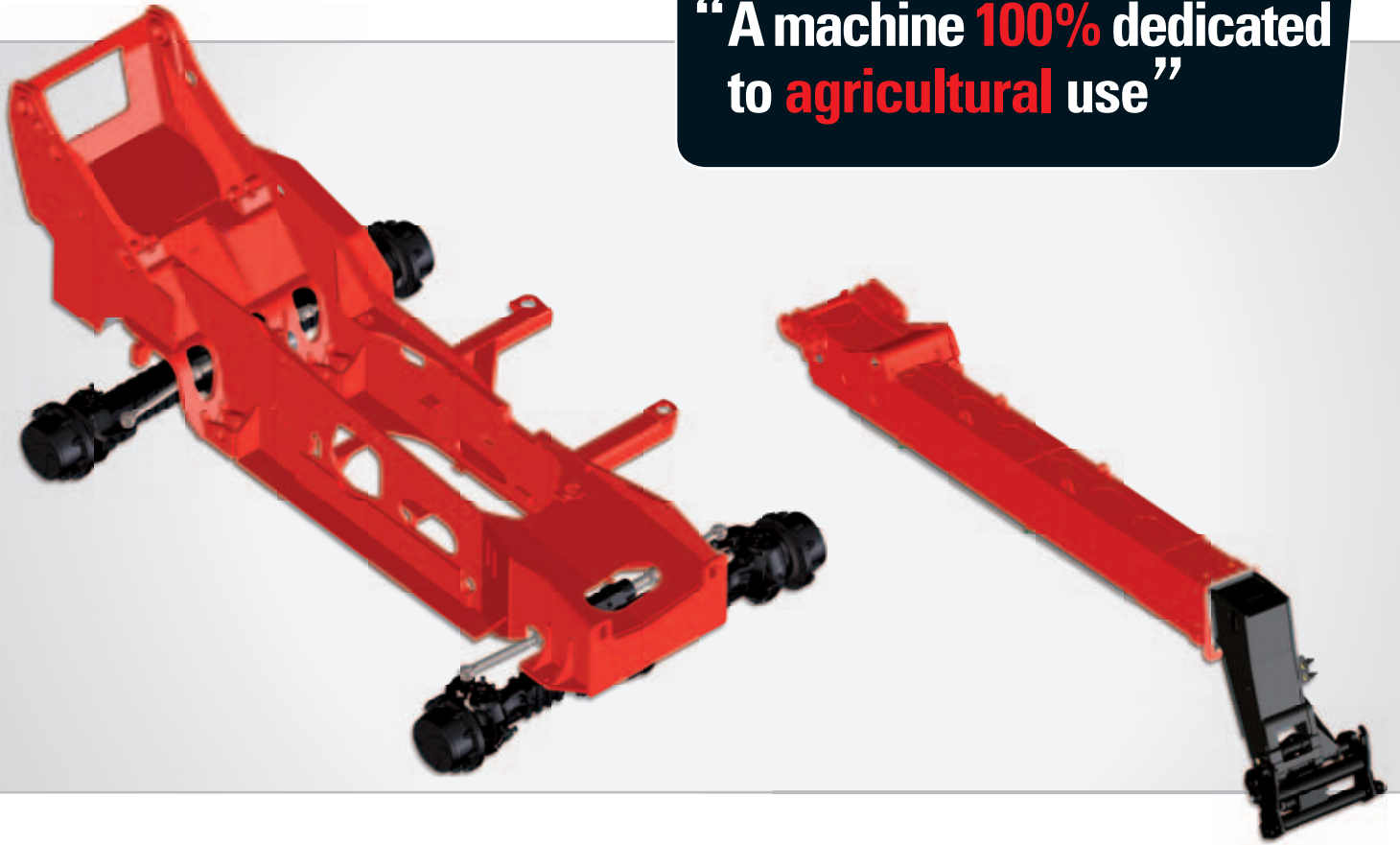

YOU ARE PROTECTED

Your working environment must above all be a safe area.

The excellent **stability** of the MLT 845 combined with the aggravating movement arrestor allows you to handle loads up to **4.5 tonnes** with complete confidence.

Your **safety** is further reinforced by the **presence detector** located in the seat. Travel movements are only allowed when you are sitting in the driving seat.

The cab has been especially designed to **protect** you. Satisfying **ROPS/FOPS*** requirements, withstanding rolling over, heavy objects falling and therefore prevents distortion to the cab.

A large window area, lateral engine, low boom pivot as well as the high seating position gives you **360° visibility** guaranteeing both your own safety and that of everyone around you.

* ROPS: rollover protection structure
FOPS: falling objects protection structure



SEE FURTHER

OFFERING YOU **MADE-TO-MEASURE SERVICES**

The close proximity of a network of experts at your service.

Your local Manitou dealer is dedicated to providing a first class after sales back up. The know-how, experience and commitment of Manitou, at more than 500 dealers throughout the world, ensure you will have professional support on a daily basis.

Maintenance and after-sales service: so that your telehandler is operational all year round, your dealer can offer you maintenance contracts. You will reduce your usage costs and have the guarantee of your equipment being regularly monitored. Manitou is committed to maintaining your productivity on a daily basis.

Leasing and finance agreements: your Manitou dealer is your best partner. For financial solutions, we help provide you with specific finance and modular packages to support you as your business develops.

- **COMFORT SERVICE:** a maintenance contract comprising consumables, labour and travel for maximum peace of mind.
- **MANIPLUS:** a contract which extends the manufacturer's guarantee by 24 to 36 months.





“Accompanying
the changes in
your business”

REDUCE YOUR ECOLOGICAL FOOTPRINT



From the design stage of your machine, Manitou does everything to **respect the environment**.

Our Ancenis production site, certified **ISO 14001***, guarantees that environmental standards are included from the design stage of the product up to the delivery of the machine to your business. Daily routine procedures include the selection of the least polluting components, selective sorting, treatment of special wastes and quite simply daily vigilance (energy, paper savings, etc.).

The optimum management of the engine speed according to the power demanded **minimises your consumption** and your polluting emissions, thus reducing the impact of the use of your MLT on the environment.

* ISO 14001 : international environmental management standard which lays down requirements relating to the implementation of an environment management system.

YOU CHOOSE

Standard and optional equipment	 CLASSIC	 PREMIUM	 ELITE
Fork carriage	●	●	●
Straw deflector	●	●	●
Rear-view mirror	●	●	●
Radiator auto cleaning system	●	●	●
Radio player	●	-	-
CD/MP3 car radio	○	●	-
Bluetooth car radio	○	○	●
Mechanical cloth seat	●	-	-
Pneumatic cloth seat	○	●	-
Low-frequency pneumatic cloth seat	○	○	●
Air conditioning	○	●	●
Easy Connect System	○	●	●
Boom suspension	○	○	●
Self-cleaning pre-filter	○	○	●
Hydraulic locking (accessories)	○	○	○
TURBO II pre-filter	○	○	○
Reversing warning buzzer	○	○	○
Internal rear-view mirror	○	○	○

● Standard ○ Option - Not available

A selection of attachments available:



Multifunction grab bucket

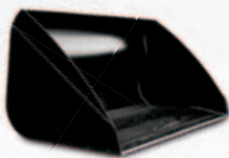

Grain bucket



Collector brush

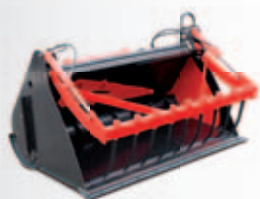

Silo unloader-distributor bucket



HP self washer

MLT 845

	MLT 845-120 H	MLT 845-120
	Lifting capacity at 500 mm from fork heels Break-out force	
	4500 kg 6650 daN	
	Lifting height Time: laden/unladen (in sec)	
	7.55 m Lifting: 8.40/9.00 Lowering: 6.00/5.80 Extension: 9.70/9.90 Retraction: 8.30/8.20 Crowd: 3.70 Dump: 3.30	
	Tyres 460/70 R24	
	Forks (mm) Length x width x thickness Carriage rotation	
	1200 x 125 x 50 142°	
	Braking multiple-disk brake with oil bath on front and rear axles	
	MERCEDES STAGE III A engine OM-904LA Cubic capacity Power at 2200 rpm (ISO/TR 14396) Max. torque at 1600 rpm (ISO/TR 14396) Injection Cooling	
	Turbo 4 cyl./4250 cm ³ 121 HP/90 kW 470 Nm direct water	
	Transmission Gearbox Number of gears (forward/reverse) Max. travel speed	
	hydrostatic - 2/2 28 kph*	torque converter Powershuttle 4/4 33 kph*
	Hydraulics Piston pump Control valve	
	150 l/min - 270 bar electronically controlled variable cubic capacity DDIC	
	Capacities Hydraulic oil Fuel	
	131 l 135 l	
	Unladen weight (with forks) Width overall Height overall Length overall Turning radius (outer wheels) Ground clearance Drawbar pull Noise at driving position (LpA) Environmental noise (LwA) Vibration to whole hand/arm	
	8870 kg 8816 kg 2.42 m 2.58 m 5.22 m 4.16 m 0.45 m up to 10355 daN 80 dB 106 dB < 2.5 m/s ²	

Maximum height reach: 1.46 m

As per standard EN 1459 annex B

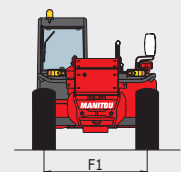
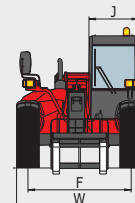
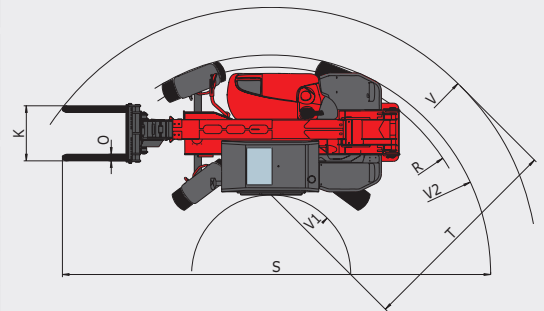
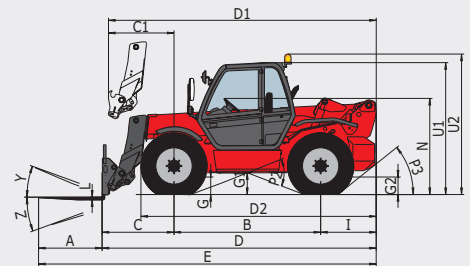
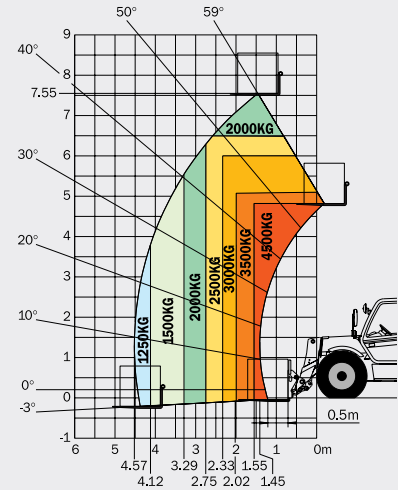

mm									
A	1200	D2	4410	I	1050	P3	40°	V1	1470
B	2770	E	4410	J	950	R	3930	V2	4165
C	1409	F	6429	K	1260	S	8159	W	2420
C1	1487	F1	1950	L	50	T	3703	Y	12°
D	5229	G	455	N	1865/1915	U1	2580	Z	130°
D1	5307	G1	450	O	125	U2	2760		
		G2	455	P2	43.5°	V	5173		

This brochure describes versions and configuration options for Manitou products which may be fitted with different equipment. The equipment described in this brochure may be standard, optional or not available depending on version. Manitou reserves the right to change the specifications shown and described at any time and without prior warning. The manufacturer is not liable for the specifications given. For more information, contact your Manitou dealer. Non-contractual document. Product descriptions may differ from actual products. List of specifications is not comprehensive. The logos and visual identity of the company are the property of Manitou and may not be used without authorisation. All rights reserved. The photos and diagrams contained in this brochure are provided for information only.

MANITOU BF SA - Limited company with board of directors - Share capital: 39,547,824 euros - 857 802 508 RCS Nantes



Your nearest **MANITOU** dealer:



Head office:
B.P. 249 - 430 rue de l'Aubinière - 44158 Ancenis Cedex - France
Tel: 00 33 (0)2 40 09 10 11 - Fax: 00 33 (0)2 40 09 10 97
www.manitou.com